

INSTRUCTION MANUAL

PORTABLE MAGNETIC DRILLING MACHINE

Read this manual carefully before operating your Nitto Kohki Portable Magnetic Drilling Machine. Keep this manual with your machine. All users of the Nitto Kohki Portable Magnetic Drilling Machine must read this manual.

ATRA ACE Model AO-5575A Professional Tool

For One-Touch Type Annular Cutter Only
(Side-Lock Type Annular Cutter cannot be used.)

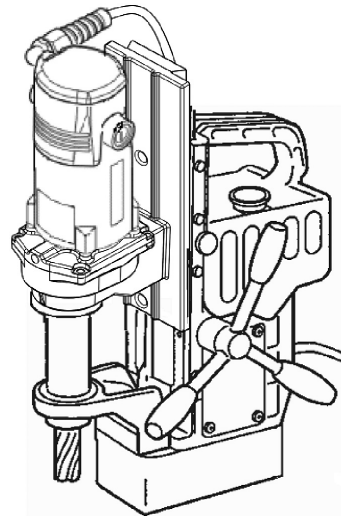

Specifications

Model		AO-5575A
Power Supply (Single Phase)		220-240 V AC 50/60 Hz
Drill Motor	Rated Power Consumption	950 W
	Rated Current	4.3 A
	No-load Speed	520 min ⁻¹
	Load Speed	300 min ⁻¹
Magnet Power Consumption		50 W
Hole Capacity	JETBROACH One-touch type	Max. Hole Diameter 55 mm dia. Max. Plate Thickness 75 mm
	HI-BROACH One-touch type	Max. Hole Diameter 50 mm dia.
	AUSTBROACH	Max. Plate Thickness 50 mm
Magnet Holding Power		10 kN
Magnet Size		86 × 170 mm
Weight		17.5 kg

The specifications and configurations contained in this document are subject to change without prior notice due to improvements we are making day in, day out.



Manufactured by :

NITTO KOHKI Co., Ltd.

9-4, NAKAIKEGAMI
2-CHOME, OHTA-KU,
TOKYO, 146-8555, JAPAN
Tel : +81-3-3755-1111
Fax : +81-3-3753-8791

Keep the manual handy – so you can use it whenever necessary.

Original Instructions

TQ15123-0 04/2017

Thank you very much for your purchase of **Nitto Kohki product**.

Before using your machine, please read this manual carefully so that you may use it properly to get the most out of it.

Please keep the manual handy - so you can use it whenever necessary.

- English :Please ask your dealer or distributor for instruction manual in local language(s).
- German :Bitte fragen Sie Ihren Händler nach eine Betriebsanleitung in Landessprache.
- French :S'il vous plait, veuillez demandez à votre fournisseur de manuel instruction en langue locale.
- Spanish :Por favor, contacte con su distribuidor para el manual de instrucciones en español.
- Portuguese :Por favor pessa ao seo agente ou distribuidor o manual de instrucces ih linguagen local.
- Italian :Per Manuale Istruzioni in lingua locale Vi preghiamo di rivolgervi al rivenditore o distributore.
- Dutch :Vraag uw handelaar om een nederladstalige gebruiksaanwijzing.
- Swedish :Be er lokala Åtreförsäljare eller distributör om manualer på svenska.
- Danish :Venligst henvend Dem til den danske distributør for instructions manualer.
- Polish :Prosze pytac swojego dealera lub dystrybutora o instrukcje obslugi w jezyku localnym.
- 中文 :請向當地供應商或經銷商詢問中文使用說明書

CONTENTS	page
GENERAL SAFETY RULES	2
POWER TOOL SAFETY	3
ABOUT YOUR NITTO PORTABLE MAGNETIC DRILLING MACHINE	4
1. APPLICATION	7
2. RECEIVING INSPECTION	7
3. PART NAMES	8
4. FUNCTIONS OF ELECTRONIC CONTROL	9
5. MACHINE SETUP	9
6. MACHINE OPERATION	12
7. TROUBLESHOOTING	15
8. MAINTENANCE/SERVICE	16
9. OPTIONAL PARTS	17
10. ORDERING PARTS	19
11. EXPLODED DIAGRAM	20

PICTOGRAM

 Warning: It might be dangerous to operate the power tool if the instructions supplied are not followed.

 Do not allow the main body or the power source to get wet as it will cause electric shock and leakage.

 Using this tool improperly could result in serious injury. Read the instruction manual before using.

 Always wear suitable eye protection.

 Always wear suitable hearing protection.

 Always wear respiratory protective equipment (PPE).

· Sound Pressure Level :Maximum 85dB(A) according to Clause 1.7.4(f), Annex I, Machinery Directive.

· Sound Power Level :Maximum 91dB(A)

· Operating Temperature :5°C ~ 40°C



· Operating Humidity :Maximum 90% at 25°C

· Over-voltage Category :Category II according to IEC664-1

· Pollution Degree :Degree 3 according to IEC664-1

· Wiring Diagram No. :TZW0158

The following Safety notations are used throughout the manual to highlight safety precautions for the user and for the machine.

 DANGER:	Indicates an imminently hazardous situation which, if not avoided by following the instructions given, will result in death or serious injury.
 WARNING:	Indicates a potentially hazardous situation which, if not avoided by following the instructions given, could result in death or serious injury.
 CAUTION:	Indicates a potentially hazardous situation which, if not avoided by following the instructions given, could result in injury or material damage.

Caution: Important precautions for machine or tool setup, operation and maintenance.

WARNING

Some dust created by power sanding, sawing, grinding, drilling, and other construction activities contains chemicals known [to the State of California] to cause cancer birth defects or other reproductive harm.

Some examples of these chemicals are:

- Lead from lead-based paints,
- Crystalline silica from bricks and cement and other masonry products, and
- Arsenic and chromium from chemically-treated lumber.

Your risk from these exposures varies, depending on how often you do this type of work. To reduce your exposure to these chemicals: work in a well ventilated area, and work with approved safety equipment, such as those dust masks that are specially designed to filter out microscopic particles.

GENERAL SAFETY RULES

WARNING

TO OPERATORS

Always Wear Proper Clothing

- Do not wear loose clothing. Loose clothing can become caught in the drilling machine. This could cause severe injuries. Be careful that loose clothing does not come into contact with the machine.
- Wear non-skid footwear. If you lose your footing, you could contact moving portions of the machine. This could cause severe injuries. Always wear non-skid footwear and remain balanced when using the drilling machine.
- Be careful of long hair. Wear a hat or a hair net to contain long hair. Long hair can become caught in the drilling machine. This will cause severe injuries. Be careful that long hair does not come into contact with the drilling machine.

Always Wear Suitable Eye Protection

- Always wear suitable eye protection. The operation of your drilling machine will cause flying chips and particles. These will cause severe eye injuries. You must always wear suitable eye protection.
- Not all glasses are suitable eye protection. Wear only suitable eye protection that comply with ANSI standards. Not all of the lenses are shock resistant. Ordinary glasses will not provide sufficient eye protection.

Always Wear Suitable Hearing Protection

- Always wear suitable hearing protection. The operation of your drilling machine will cause big sound

occurs. These will cause severe hearing loss injuries. You must always wear suitable hearing protection

Always Wear respiratory protective equipment (PPE)

- Always Wear respiratory protective equipment (PPE) when working in an environment where dust particles are generated in operation.

Maintain Good Posture

- Always wear non-skid footwear and maintain good posture. Do not use the drilling machine when you are tired. Fatigue or loss of balance could cause you to lose control of the machine. This could cause severe injuries. Always stay balanced. Always keep good posture. Stop using the machine if you are tired.

Never Touch the Cutting Tip

- Never touch the moving or cutting tip. Contact with the moving tip will cause severe injuries. Always keep all parts of your body away from the cutting tip. Always keep your hand and clothing away from the cutting tip.

ABOUT THE WORK AREA

Keep Work Area Clean

- Always keep your work area clean. Cluttered work areas cause accidents. Always keep clear of other objects.
- Never use the magnetic drilling machine when it is wet. Always use the drilling machine in a dry area. Do not use the drilling machine in the rain. If you use the machine when it is wet you can get electric shock. If you use the machine in the rain you can get an electric shock.
- Always use the drilling machine in a well-lighted area. Do not use the drilling machine in the dark.
- Avoid all flammable materials. Use of the drilling machine may cause a spark that could ignite a fire or an explosion. Never use the machine near any flammable material.
- Keep away from children. Always keep the drilling machine away from children. Do not operate drilling machine when children are present.

BEFORE OPERATION

Make sure that all parts are free from damage

- Make sure that the drilling machine is in good operating condition. Operation of a damaged machine could result in severe injuries. If there is any damage to the machine, do not use the machine. If there is any damage to the machine, take it to an authorized Nitto dealer for repair.
- Do not attempt service or repair of the drilling machine. All service or repair should be done by an

authorized Nitto dealer.

Secure Your Work

- Always secure your work piece. Improperly mounted work can become loose. This can cause severe injuries. Always secure all work.
- Always use a vice or a clamp. Do not attempt to hold any work piece with your hand. Attempting to hold a work piece with your hand may cause severe injuries. Always use a vice or clamp to hold the work piece.
- Always secure your drilling machine. Improperly mounted drilling machine can come loose. This can cause severe injuries. Always secure the drilling machine.

Avoid Clutter

- Always stay clear of other objects. Cluttered work areas cause accidents. Always keep a clean work area and stay away from other objects.

Always Remove Spanner Wrenches and Adjustment Tools

- Always remove spanner wrenches and adjustment tools after adjustments have been made to the drilling machine. Always remove all adjustment tools before using the drilling machine.

Always Use a Cutter that is Appropriate for Your Work

- Always use a Cutter that is appropriate for your work. Avoid heavy-duty work that is the beyond the capacity of your drilling machine. If the work exceeds the capacity of your drilling machine, this can cause accidents and severe injuries. Always use the drilling machine in accordance with its performance specifications.

SAFE HANDLING

- Never leave the magnetic drilling machine unattended while it is running. When the machine is unattended, disconnect the power source. Do not leave the work area until the machine comes to a complete stop. Operating the machine while it is unattended can cause accidents that may result in severe injuries.

HOW TO STORE YOUR MAGNETIC DRILLING MACHINE

- Always store the machine in a dry area.
- Always keep the machine out of the reach of children.

HOW TO CARRY YOUR MAGNETIC DRILLING MACHINE

- Disconnect the power and turn off the machine whenever you carry the machine.

MAINTENANCE

Do not take apart or modify your magnetic drilling machine.

- Do not attempt to disassemble or modify your magnetic drilling machine.
- Do not modify your magnetic drilling machine. Modifications can cause accident and severe injuries.
- All service and repairs must be performed by an authorized Nitto dealer. Any attempt to service or repair the machine yourself may result in an accident and severe injuries.

Check all Parts for Damage.

- Always inspect the magnetic drilling machine before use.
- Always check that the pilot pin and cutter are in good condition. Use of the machine with worn pilot pins or worn cutter can cause accidents and severe injuries.
- Inspect all cutter before you put them on the magnetic drilling machine.
- Do not operate the magnetic drilling machine with a damaged or worn cutter. Do not operate the machine with a damaged or worn pilot pin. Do not operate the machine with any damaged accessory. Operating the machine with any damaged part or accessory can cause accidents and severe injuries. If there is any damage to the magnetic drilling machine do not operate the machine. Take it to an authorized Nitto Dealer for repair.
- Always have the magnetic drilling machine repaired at an authorized Nitto dealer. Always take the magnetic drilling machine to an authorized Nitto dealer for service, repair and replacement parts. If you cannot locate an authorized Nitto dealer near you, please contact your sales representative.
- Always use Nitto genuine parts. The use of improper or non-Nitto parts can cause accidents and severe injuries. Never use unauthorized parts. To obtain genuine Nitto parts, contact your sales agent.
- Do not remove any nameplate from your magnetic drilling machine. Do not remove any labels from your magnetic drilling machine. If any label or nameplate is damaged contact your sales agent for a replacement.

POWER TOOL SAFETY

WARNING

- Always make sure that the machine is properly grounded. If the machine is not properly grounded, someone can get an electric shock.

- If you have any doubt about the grounding of the magnetic drilling machine, contact a licensed electrician.
- Never connect the grounding conductor to a gas pipe. This will result in an explosion and severe injuries or death.
- Always check the grounding conductor. If you have any doubts about the grounding conductor contact a licensed electrician.
- Wiring connections to a grounding rod require the expertise of a licensed electrician. Do not attempt the wire connections yourself. Always contact a licensed electrician.
- Do not abuse the power cord. A damaged power cord can cause an electrocution. A damaged power cord can cause fires. Always inspect the cord. If the cord is damaged, do not use the magnetic drilling machine.
- Do not carry the machine by the cord. Do not pull the cord to disconnect it from a socket.
- The cord can become damaged from heat, contact with sharp objects or from being twisted. Always inspect the cord. Do not use the machine if the cord is damaged.
- Always use a ground fault circuit interrupter. The use of a ground fault circuit interrupter may be required by government regulations. The failure to use a ground fault circuit interrupter may result in electric shock.
- Avoid starting the magnetic drilling machine abruptly or unintentionally.
- Always make sure that the switch is turned off before connecting the power source.
- Always disconnect the power source and turn off the switch before setting up for work operations. Always disconnect the power and turn off the switch when inspecting work. Always disconnect the power and turn off the switch before attempting any maintenance. Failure to disconnect the power and turn off the switch during set up, inspection or maintenance can cause accidents and severe injuries.

ABOUT YOUR NITTO PORTABLE MAGNETIC DRILLING MACHINE

DANGER

Do not use your portable drilling machine on the ceiling.

- Use of the portable drilling machine on the ceiling is dangerous. The machine could fall. The falling machine could cause severe injuries or death. (Fig.1)

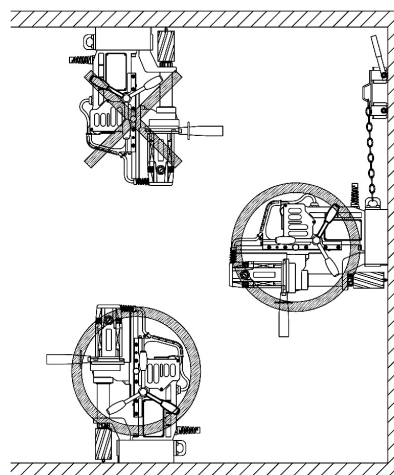

Fig. 1

WARNING

Do not use the Magnet for more than five hours.

- More than five hours of uninterrupted operation may cause a fire. Five hours of uninterrupted operation generates extreme heat in the Magnet. This heat can cause a fire. Do not touch the Magnet. When the Magnet is hot, touching it will cause a severe burn injury. Never use the Magnet for more than five continuous hours. When you are not using the Magnet, turn the switch to the OFF position and pull the Plug out of the power source.

Do not use the Drill Motor for over 30 minutes.

- Uninterrupted operation of the Drill Motor for over 30 minutes generates heat. This heat can cause a fire. Never use the Drill Motor for over 30 minutes. When you are not using the Drill Motor, turn the switch to the OFF position and pull the Plug from the power source.

Use only on magnetic materials.

- Your portable drilling machine cannot be used on non-magnetic materials, such as aluminum, stainless steel, copper or alloys. The Magnet will not work on non-magnetic materials. Attempting to use the Magnet on non-magnetic materials could cause an accident.

Use caution during wall operation.

- When using your portable magnetic drilling machine on a magnetic wall, always use caution.
- Never stand under the machine.
 - * Never allow anyone to stand under the machine.
 - * Never put any part of your body under the machine.
 - * If the machine falls, it could result in severe injury or death.
- Always remove Cutting Oil from the Tank before using the machine on a wall. You must manually apply Cutting Oil to the cutting tool.

Always use a work piece that is at least 9 mm thick.

- The work piece must be at least 9 mm thick. If a work piece is too thin, the magnetic power of your machine will decrease. This will cause the machine to move during operation. This could result in an accident. (Fig.2)

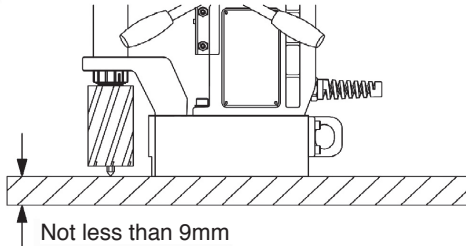

Fig. 2

Use an iron back-up plate.

- If the work piece is less than 9mm thick, you must use an iron back-up plate that is more than 10 mm in thickness. The surface area of the iron back-up plate must be greater than the surface area of the magnet. An appropriate back-up plate is necessary to boost the holding power of the Magnet.(Fig.3) Use of an inappropriate back-up plate can result in an accident, If the back-up plate is not thick enough or big enough, the machine will come loose during operation. This can result in an accident and severe injuries.

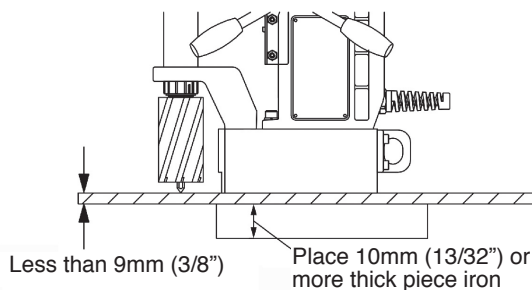

Fig. 3

Always keep surfaces clean.

- Always keep the Magnet surface clean. Always keep the work piece surface clean. If there are any foreign objects between the Magnet and the work piece surfaces, this will reduce magnetic power. This could cause the machine to move during operation. This can result in an accident. Keep all surfaces clean of rust, chips or other foreign material.

Do not place the machine over a hole.

- Do not attempt to position the Magnet over a hole. Attempting to straddle a hole will reduce the power of the Magnet. This will cause the work piece to come loose during operation and can cause an accident.

Always use a chain to secure the machine.

- If the machine falls, it can cause severe injuries. There is always a possibility that magnetic power can be lost or reduced because of a power failure. Magnetic power can be lost on rough surfaces. You must take precautions to prevent the machine from falling.
- This machine comes with a chain. The chain is to be used to fasten the machine to the work piece. If you do not use the chain, it is possible that the machine may fall. (Fig.4)
- If use of the chain is not possible because of the size of the work piece, you must use another method of securing the machine. Use a Supporting Magnet Assy to prevent the machine from falling.
- The use of a Supporting Magnet Assy is shown below. (Fig.5)

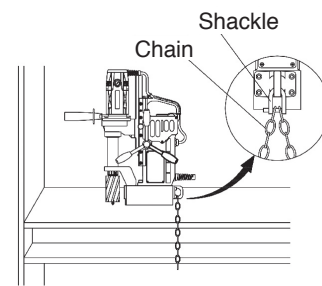

Fig. 4

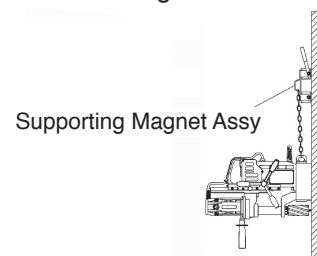

Fig. 5

Always set the Magnet in the proper position.

- Always set the Magnet parallel to the longitudinal direction of the material. Failure to set the Magnet in the proper position may result in reduced magnetic power. This can cause the machine to move in operation. This can cause an accident resulting in severe injuries.
- When using on H-section steel, as shown in the figure below, set the Magnet in a direction parallel to the longitudinal direction of the material. This will ensure that the Magnet is in the best position for magnetic attraction.(Fig.6)
- Poor magnetic power may result in damage to the cutter or damage to the work piece.

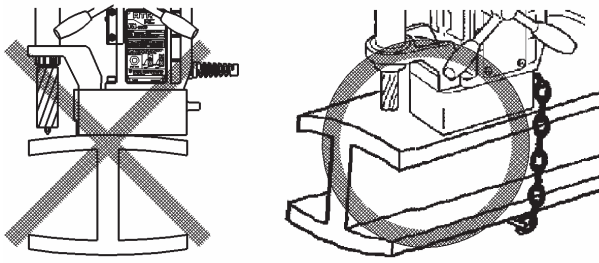

Fig. 6

Be careful about chips.

- Keep your hands away from the cutting area at all times. During drilling, there will be chips. The chips are sharp. The chips are rotating with the cutter. Any contact with the chips can cause severe injuries.

Do not touch the slug.

- Do not touch the slug. The slug is very hot. It will cause severe burns. Make sure that no one touches the slug. Make sure that there is no one below the work area during operation. Hot slugs will fall. Hot slugs can cause severe burns, other severe injuries, or even death. Always wear protective equipment, including protective headgear, eye protection, hearing protection, and gloves. Do not allow any person without protective equipment to come near the machine.

Do not use your hands to remove chips.

- Chips have sharp edges. Use a screwdriver to remove chips. If you use your hands to remove chips, you can be injured, even if you are wearing gloves. Do not use your hands to remove chips under any circumstances.

The cutting edge is sharp.

- Always wear gloves when changing the cutter. The cutting edge is sharp. If you do not wear gloves, you will be cut. Attempting to change the cutter can result in severe injuries.

Do not use Cutting Oil for other purposes.

- Cutting Oil should be used only for drilling. Please refer to Section 5-5 of this manual for further warnings and instructions about Cutting Oil.

CAUTION

Always use a compatible Pilot Pin.

- The Pilot Pin must be compatible with the cutter. An improper Pilot Pin may result in an accident. See Section 5-3 to identify compatible Pilot Pins and cutters. The proper Pilot Pin to be used will vary, depending on the type of cutter, the diameter of the cutter, and the length of the cutter.

Do not use power that is generated by an engine-driven welder.

- The use of an engine-driven welder as a power source may cause your magnetic driven machine to malfunction, Power from an engine-driven welder can damage the electronic circuits in your portable drilling machine.

Use a Proper extension cord.

- Do not use an extension cord that is too thin. Do not use an extension cord that is too long. Do not use an extension cord that is wound on a drum. Do not share an extension cord with other motor-driven tools. These uses can cause voltage to drop and can reduce the holding power of the magnetic base, causing the machine to move during operation. This can decrease performance and may cause damage to the machine. (Fig.7)

Extension Cord	
Max length	Size (nominal cross-section area of the conductor)
10 m	Min 1.25 mm ² or more
20 m	Min 2.00 mm ² or more
30 m	Min 3.50 mm ² or more

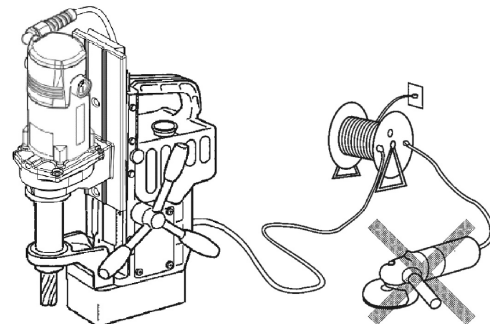

Fig. 7

Don't use this machine on the steel material being electrically welded.

- When the electric welder is not properly grounded, electricity will run through the Atra Ace machine via its Magnet, causing possible failure or malfunctioning, which in turn may cause accident.

Don't force to feed cutter when drilling manually.

- Because the Hi-Broach and Jet-Broach have rather thin cutting edges with less cutting pressure resistance as compared to twist drill, do not force to feed the cutter when drilling manually. If you feed it with too much force, the cutter may break or end up with shorter life than otherwise.

1 APPLICATION

This is a portable drilling machine with a Magnet, geared to drilling mild steel (mild steel or equivalent) using One-Touch type Jet-Broach or Hi-Broach. The machine will be mounted on the workpiece to be drilled with the Magnet securely fastening the machine to the workpiece while drilling takes place.

2 RECEIVING INSPECTION

Upon unpacking, check to see that the shipment is complete without damage or oil leakage in transport. Should you find any damage or short-shipment, please contact sales agent through which you have purchased your machine or an authorized dealer near you for corrective actions.

Package Contents	Q'ty	Check
ATRA ACE	1set	
Pilot Pin 08050	1	
Hex. Socket Screw Key 3	1	
Hex. Socket Screw Key 5	1	
Spanner 8X10	1	
Cutting Oil 0.5ℓ Can	1	
Sub Handle	1	
Chain	1	
Guard	1	
Instruction Manual	1	

3 PART NAMES

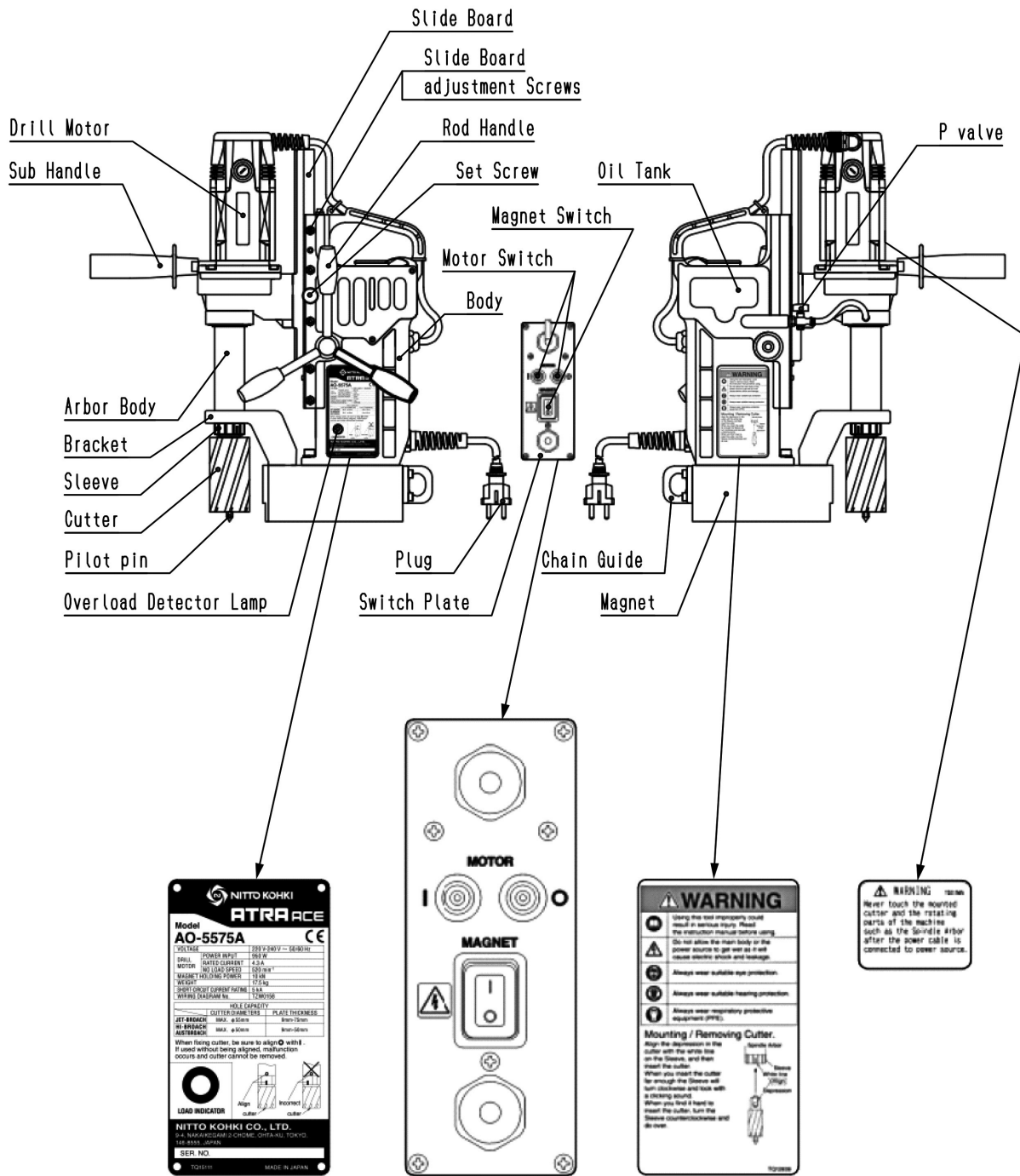

Fig. 8

4 FUNCTIONS OF ELECTRONIC CONTROL

4-1. Overload Detecting Function

WARNING

- Don't touch the cutter even if the Drill Motor stops temporarily.

When the Magnet Switch is turned to ON, a lamp on the side of main body will light up in green.

As the drilling operation load increases, the lamp will change in color from green to orange to red. In addition, if the feeding force is further increased, the lamp will rapidly blink in red and the rotation of the Drill Motor will slow down and finally stop temporarily. If the load is released while the lamp is blinking in red the Drill Motor will resume its rotation. If the load is not released, the Drill Motor will come to a complete stop and the lamp will blink in green. To resume the rotation of the Drill Motor release the load and turn on the switch of the Drill Motor.

4-2. Lateral-Shifting Detection Function

This function stops the Drill Motor when lateral shifting of the Magnet base is detected.

As this function comes into action, the lamp will blink in orange.

To continue operation, turn OFF the Magnet Switch and, after confirming the drilling position, turn ON the Magnet Switch again, and turn ON the Drill Motor switch to start rotation of the Drill Motor.

4-3. Re-Start Prevention Function

The re-start prevention function comes into play when power failure is restored that has occurred during operation.

Thanks to this feature, when a plug that has been disconnected during operation is re-plugged into the receptacle or when power failure that has occurred during operation is restored, the Drill Motor will NOT restart automatically preventing possible accident -- although Magnet Switch lamp will come on and magnetic power restored.

To resume operation, turn ON the Motor Switch on the rear of the machine to start the Drill Motor.

4-4. Magnet Interlocking Function

If the magnet is disconnected, the lamp will blink in red and the Drill Motor will not revolve.

When the Magnet fails the Drill Motor will not start revolving. To repair defective Magnet, please contact sales agent through which you have purchased your machine or an authorized dealer near you.

5 MACHINE SETUP

WARNING

- When setting up machine, turn off the Magnet Switch and disconnect the power supply plug from power source.

5-1. Mounting Parts

Mount the Side Handle on the Drill Motor.

5-2. Using Cutter

CAUTION

- Use One-Touch type cutters only.
- For better workability and safety, do not use worn or damaged cutters.

5-3. Combination of Cutter and Pilot Pin

CAUTION

- Do not use any other combinations than those shown in the compatibility table.

Use a Pilot Pin appropriate for the cutter. (Fig.9)

A Pilot Pin to be used varies depending on the cutter type, diameter, length (depth). A wrong combination of cutter and Pilot Pin would not allow slug to be ejected at the end of drilling and/or prevent Cutting Oil from reaching the cutting point, resulting in cutting tool damage.











PILOT PIN		HI-BROACH Cutters	
06025	PN:TK01167 6.35 dia. 81 mm	HBO 12 to 17 dia. Depth 25 mm	
08025	PN:TJ12696 8 dia. 76 mm	HBO 17.5 to 50 dia. Depth 25 mm	
06050	PN:TK01166 6.35 dia. 112 mm	HBO 12 to 18 dia. Depth 50 mm	
0850	PN:TK00802 8 dia. 100 mm	HBO 19 to 50 dia. Depth 50 mm	
08050	PN:TJ16019 8 dia. 112 mm		
PILOT PIN		JETBROACH Cutters	
06025	PN:TK01167 6.35 dia. 81 mm	JBO 12 to 17 dia. Depth 25 mm	
08035	PN:TJ15859 8 dia. 91 mm	JBO 17.5 to 40 dia. Depth 35 mm	
06050	PN:TK01166 6.35 dia. 112 mm	JBO 12 to 17 dia. Depth 50 mm	
08050	PN:TJ16019 8 dia. 112 mm	JBO 17.5 to 55 dia. Depth 50 mm	
08075	PN:TJ17436 8 dia. 133 mm	JBO 17.5 to 55 dia. Depth 75 mm	

Fig. 9

5-4. Mounting/Removing Cutter

WARNING

- Wear safety gloves when replacing cutter.

CAUTION

- Do not use any other combinations of Pilot Pin and cutter than those shown in the compatibility table.

- (1) Bring the Drill Motor up by turning the Rod Handle clockwise. (Fig. 10)

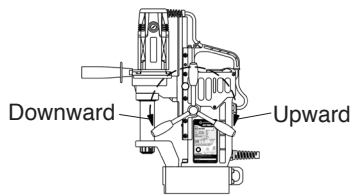

Fig. 10

- (2) Insert a Pilot Pin, appropriate for the cutter size, into the cutter. (Fig.11)

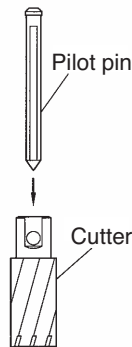

Fig. 11

- (3) Align the depression in the cutter with the white line on the Sleeve, and then insert the cutter.

When you insert the cutter far enough the Sleeve will turn clockwise and lock with a clicking sound.

* When you find it hard to insert the cutter, turn the Sleeve counterclockwise and do over. (Fig.12)

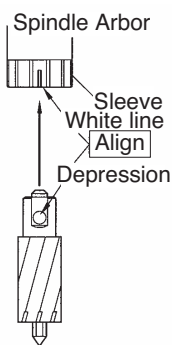

Fig. 12

- (4) To remove the cutter, turn the Sleeve counterclockwise. The cutter will come off. (Fig.13)

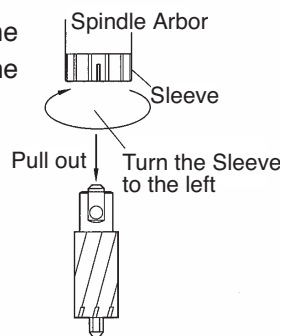

Fig. 13

5-5. Preparation of Cutting Oil

Cutting Oil Safety Precautions

WARNING

(1) Use

- Use Cutting Oil for cutting purpose only. Don't use it for household purposes

(2) Handling Precautions

- The Cutting Oil contains amine. Do not mix it up with rust inhibitor, etc. containing nitrite.
- Wear safety glasses for eye protection when handling Cutting Oil: eye injury may results if it gets into your eyes.
- Wear protective gloves for hand protection when handling Cutting Oil: skin injury may result if it comes into contact with your skin.
- Wear respirator when exposure to respiratory hazards with oil mist or vapor is anticipated. Inhalation of oil mist or vapor may make you feel sick.
- When diluting Cutting Oil, follow the instructions per the Operation Manual.
- Keep Cutting Oil out of reach of children.
- Don't drink Cutting Oil.

(3) First Aid

- If Cutting Oil gets into your eyes, immediately open your eyelids with your fingers and wash your eyes with plenty of water for at least 15 minutes. If your eyes feel irritated, consult with a medical doctor and follow his/her instructions.
- If Cutting Oil comes into contact with your skin, immediately wash it away with plenty of water and soap. Take off contaminated clothes. Clean the clothes if you need to wear it again. If your skin feels irritated, consult with a medical doctor for medical instructions.
- If someone inhales oil mist or vapor, immediately take him/her to an area where fresh air is abundant and wrap up his/her body with a blanket, etc. to keep body temperature. Have him/her take a rest and consult with a medical doctor for medical instructions.
- If someone drinks Cutting Oil, immediately make him/her drink plenty of water and vomit it. Consult with a medical doctor for medical instructions. When unconscious, do not pour water into his/her mouth nor induce him/her to vomit.

(4) Instructions in Case of Fire

- If fire breaks out in the vicinity, wear PPE (personal protective equipment) and use foam, powder or CO₂ fire extinguisher to put the fire out from the windward.

(5) Storage

- When storing Cutting Oil after use, put it into a container and put a lid on for tight sealing so that dust or moisture, which is a catalyst for contamination, may not get in.
- Avoid direct sunlight, rainwater or the like and store Cutting Oil in a dim cool area.

(6) Disposal

- For disposal of concentrate solution and used fluid, request a waste-disposal company to dispose them as industrial waste in accordance with the local laws and regulations.
- Treat flushing water through pH adjustment, condensation/sedimentation, activated sludge process, activated carbon adsorption, etc., and discharge it in accordance with the regulations of your local municipal bylaw.
- Residual dross will remain in an emptied container: be careful when handling an empty container.

(7) Others

- When Cutting Oil is poured into another container for use, post chemical and label information at the site where it is kept. At the same time, keep the Operation Manual handy so that it can be referred to whenever necessary.
- For further details, contact us for product safety data sheet.
- All the information and descriptions that have been provided are based on the currently available documents and information, which may be revised upon our new recognition and/or discovery.
- The precautions provided apply to regular handling. If special handling method is used, take safety measures that are suitable for your applications and usage.
- The information contained herein is for your reference purpose only, to which we make no warranty of any kind and for which we shall not be held responsible.

Preparation of Cutting Oil

- (1-1) Use our genuine-product Cutting Oil (blue). If other Cutting Oil is used, the cutting performance and service life of cutter would be decreased.
- (1-2) Use tap water to dilute Cutting Oil by 8- to 10-fold. Do not use well water.
- (1-3) The oil tank is of the stationary type. Remove the rubber cap and pour Cutting Oil from the Oil Tank inlet. Do not spill Cutting Oil on the machine.

5-6. Position Change of Rod Handles

- Rod Handles can be positioned either on the right or left side of the machine, by changing the Pinion Shaft insert direction as follows;
- (1) Unscrew Hex. Soc. Button Head Screw 8x15 using Hex. Socket Screw Key 5 included in the accessories.
 - (2) Pull out the Pinion Shaft Assy with Rod Handles as shown in the sketches in Fig. 14.

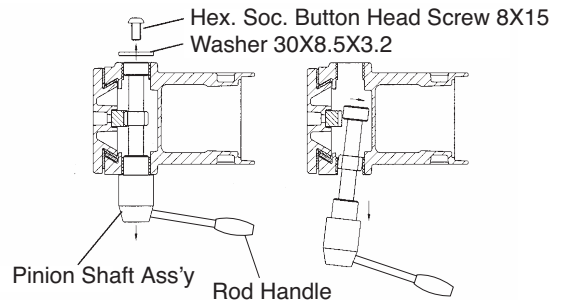

Fig. 14

Always keep the pinion teeth clean and covered with grease.

- (3) Insert the Pinion Shaft Assy from the other side of the shaft hole, and put the Screw back.

5-7. Connecting the Power Supply Plug to Power Source

- Before connecting the power supply plug to power source, turn off the switch. Always use the correct voltage for power source.

6 MACHINE OPERATION

WARNING

- Always Wear Safety Glasses.
- Always Wear Hearing Protection.
- Wear respiratory protective equipment.

CAUTION

- Do not use hard material such as a screwdriver, to operate the Motor Switch. This may damage the panel and switch, which would lead to machine failure.

6-1. Start and Stop

- The Drill Motor will not rotate unless a Magnet is turned on in operating the Motor Switch.

(1) Start

- Magnet ON (Fig.15)

Turning the Magnet Switch ON illuminates the switch lamp and energizes magnetic power.

- Drill Motor ON (Fig.16)

Turning the Motor Switch ON starts the Drill Motor.

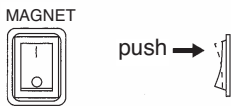

Fig. 15

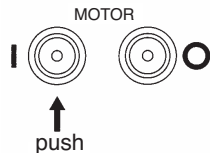

Fig. 16

(2) Stop

- Drill Motor OFF (Fig.17)

Turning the Motor Switch OFF stops the Drill Motor.

- Magnet OFF (Fig.18)

Turning the Magnet Switch OFF turns off the switch lamp and Magnet power.

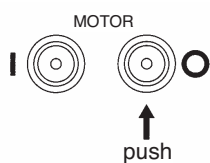

Fig. 17



Fig. 18

6-2. Drilling Procedure

(1) Punch Marking

Put a rather large punch mark in the workpiece by driving a punch down with a hammer. The punch mark will be used as a guide for drilling operation that follows, so it must be made in accurate position. (Fig.19)

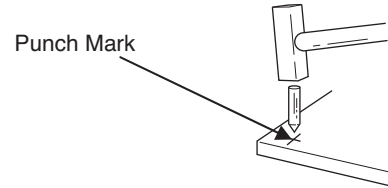

Fig. 19

(2) Keep the Magnet and Workpiece Contacting Surfaces Clean.

WARNING

- Always keep surfaces clean.

Always keep the Magnet surface clean. Always keep the work piece surface clean. If there are any foreign objects between the Magnet and the work piece surfaces, this will reduce magnetic power. This could cause the machine to move during operation. This can result in an accident. Keep all surfaces clean of rust, chips or other foreign material.

(3) Aligning with Punch Mark.

Turn the Rod Handle counterclockwise to slightly lower the cutter and align the tip of Pilot Pin to the punch mark. (Fig.20)

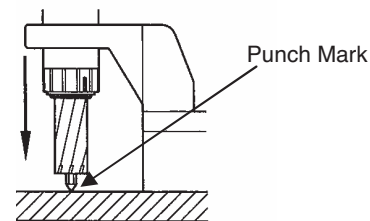

Fig. 20

(4) Magnet ON

WARNING

- **Check to see that Magnetic power is at work.**
Turn on the Magnet Switch. The switch lamp will glow and magnetic power will come on.

(5) Controlling Cutting Oil Flow.

Open the P-Valve and turn the Rod Handle. Pilot Pin will move up allowing Cutting Oil to flow.

(6) Mounting the Guard

Mounting the Guard as shown. (Fig.21)

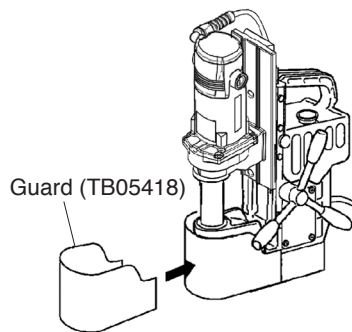

Fig. 21

(7) Oil Flow Control

After installed cutter and Pilot Pin, press the Pilot Pin on to the workpiece, and oil flow starts when P-Valve is opened. Such flow is recommended that the cutter chips be kept constantly wet during drilling and free from discoloration due to overheat burn. Drilling without enough oil causes longer cycle time and shorter cutter life.

(8) Drill Motor ON

WARNING

- **Don't touch revolving parts.**
Press the Drill Motor ON Switch to start the Drill Motor

(9) Drilling

WARNING

- **Don't press the Rod Handle strongly or the Magnet may lift, causing the main body to swing.**

CAUTION

- **Only perform drilling operation when the Overload Detector Lamp is lit in green and orange. If drilling operation continues while the lamp is lit in red, the Drill Motor may burn out.**
For the first 2 to 3mm (5/64" - 7/64") of the drilling, operate the drill gradually and only apply a light force to the Rod Handle. (Fig.22)

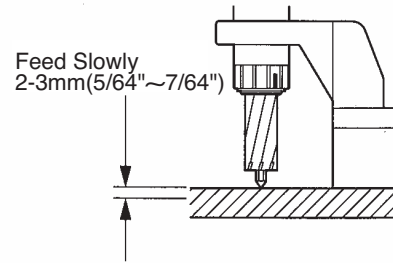

Fig. 22

When putting a hole through workpiece with a tapered bottom surface or bottom surface with a radius, such as angle, channel, H-section steel, etc., use low feed rate at the start as well as toward the end of drilling operation where the likelihood of tool chipping is high.(Fig.23)

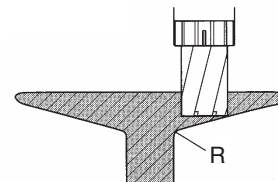

Fig. 23

(10) Finishing Drilling Operation

WARNING

- **Be careful about chips.**
- **Do not touch the slug.**
- **Do not use your hands to remove chips.**

After completion of drilling operation, lift the Drill Motor and turn OFF the Motor Switch (Fig. 24). When the Drill Motor stops, immediately turn OFF the Magnet Switch (Fig. 25). If the Magnet Switch is kept ON for a long time, the continuous current flowing through the Magnet could shorten the service life of the Magnet.

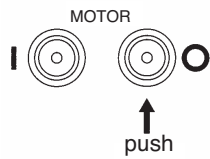

Fig. 24



Fig. 25

(11) Removing Slug

Don't proceed to the next operation without removing the slug from the operation just finished. At the end of drilling operation slug will pop out automatically ejected by the spring-operated Pilot Pin. Should a slug left in the hold sticking, remove it from the hole by tapping the collar of the slug with a needle stick or something. (Fig.26)

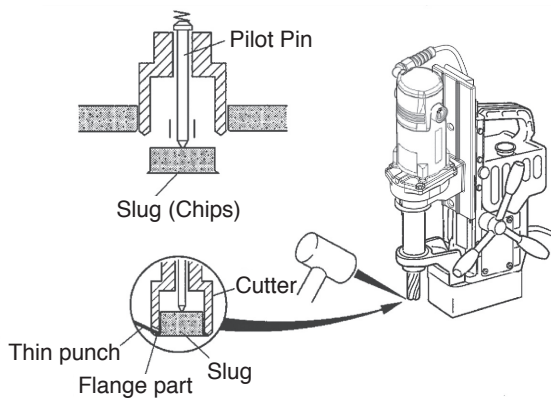

Fig. 26

6-3. Drilling Oblong Hole

! CAUTION

Always drill oblong hole slowly.

Drill oblong hole in the order of ①, ②, ③. For the steps ② and ③, take care so that the cutter may not be fed into the workpiece with too much force. Spacing between each step of drilling operations should be so arranged that the Pilot Pin will always hit the material yet to be machined. (Fig.27)

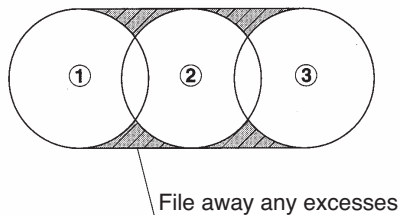

Fig. 27

6-4. Drilling Stacked Plates

! CAUTION

- Remove slug as each plated is finished: otherwise, being blocked by the slug left unremoved, the cutter cannot cut into the next layer of plate, which results in the Magnet base being pushed up possibly causing accident.
- For stacked plates drilling, always feed and drill slowly and carefully.
- Before drilling stacked plates, securely clamp the plates together in place.
- When drilling stacked plates, retract the cutter as each layer of plate is finished in order to remove slug from the drilling area, then put another hole in the next layer of plate.

7 TROUBLESHOOTING

WARNING

- Never attempt to repair machine yourself: injury or damage to equipment may result.
- Please feel free to consult the sales agent through which you have purchase your machine or an authorized dealer, when the following symptoms appear or when you have any questions about our products.

The machine has electronic control. Be sure to turn off all the switches, pull up the electric drill, and then check the machine, when the operator come across to the following situations such as.

Troubleshooting

Problem	Causes	Solutions
Switch lamp doesn't come on when Magnet Switch is turned on.	Power supply plug is not connected to socket.	Connect power supply plug to socket.
Drill Motor doesn't start when Motor Switch is turned on.	Red lamp blinks: Magnet is disconnected.	Request for repair.
	Orange lamp blinks: the workpiece is displaced after magnet attraction.	Fix the workpiece.
Drill Motor stops during drilling. (Magnet is not working with Magnet lamp not illuminating.)	Power failure has occurred or power supply plug is disconnected.	After power failure is restored or power supply plug is re-connected, turn on Motor Switch again.
The rotation of Drill Motor slows down and stops during drilling. (The lamp rapidly blinks in red.)	Feeding force is excessive.	Reduce the feeding force.
Drill Motor stops during drilling operation. (Lamp blinks in green.)	Feeding force is excessive.	Reduce the feeding force.
Lateral shifting of Magnet is detected by lateral position sensor, bringing machine to a complete stop. (Lamp blinks in orange.)	Workpiece too thin.	Use back-up plate: thickness 10 mm (13/32") or more.
	Chips under Magnet base.	Clean it up.
	Worn cutting edge.	Regrind or replace with new one.
	Effective magnetic force too weak.	Ask for repair.

8 MAINTENANCE/SERVICE

WARNING

- Always disconnect the power and turn off the switch before attempting any maintenance. Failure to disconnect the power and turn off the switch during set up, inspection or maintenance can cause accidents and severe injuries.
- Check to see periodically that mounting screws are tight. If you find them loose, retighten.

8-1. Tighten Set Screw When Machine is Not Used

For the purpose of safety, when you don't use the machine temporarily or on a long-term basis, raise the Drill Motor and set it in position with the Set Screw so that it will not come down on its own weight. If you leave the machine alone with the Drill Motor in a lowered position, the Pilot Pin and/or cutter may be damaged when the machine is relocated. (Fig.28)

8-2. Grease the Sliding Surfaces from Time to Time

Grease the machine body and Slide Board from time to time. (Fig.28)

8-3. Slide Board Clearance Adjustment

Excessive clearance between the machine body and Slide Board would deteriorate not only drilling performance but also cutting tool life to a substantial degree. If you find excessive clearance, make adjustment by tightening 5 slide board adjusting screws on the side of the machine using the same torque all round so that the Drill Motor will not come down on its own weight. (Fig.28)

8-4. Bracket Inspection and Oiling

Among other things, drilling accuracy hinges on the Bracket that supports the Arbor Body. See that the (three Hexagon Socket) Bracket mounting bolts are tight, from time to time. (Fig.28)

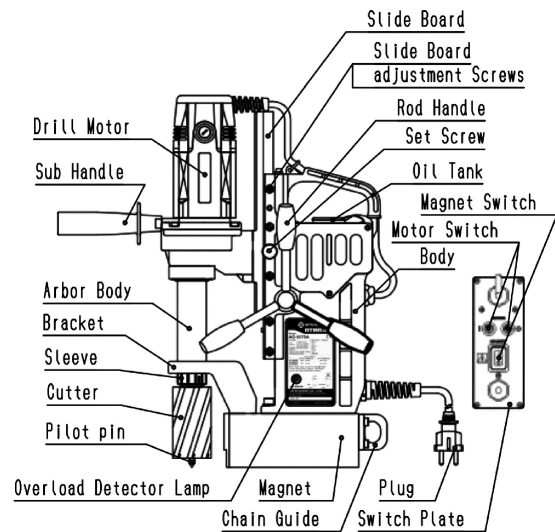

Fig. 28

8-5. Keep the Tip of Pilot Pin Sharp

When the tip of Pilot Pin gets dull, it sometimes fails to seat into punched hole, causing drilling accuracy to deteriorate. See that the tip is sharp from time to time.

If you find it too dull, regrind or replace as required. When regrinding do so carefully, for grinding with too much force may cause the tip to get dull or soften the material to such a degree that it is no longer usable. (Fig.29)

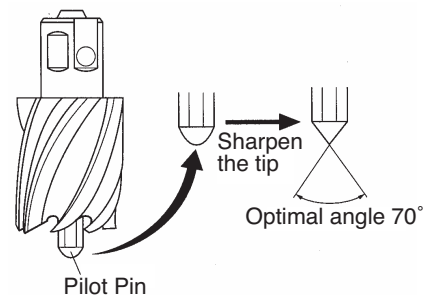

Fig. 29

8-6. Recovery Measures When Pilot Pin Gets Jammed

When you change cutting tool you also change Pilot Pin, which acts as a guide for the cutting tool. However there are times when the pin does not come off easy with cutting chips in the clearance between the cutting tool and pin, causing jamming. In such case, tap the tip of Pilot Pin with a wooden hammer, etc., and pull it off. (Fig.30)

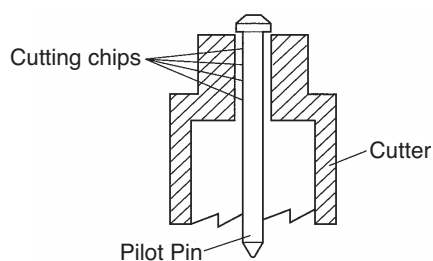

Fig. 30

8-7. Cutter Regrinding

When you need to regrind cutter, please contact sales agent through which you have purchased your machine or an authorized dealer near you.

8-8. Carbon Brushes Inspection and Replacement

Check Carbon Brushes for wear periodically.

When the length of Carbon Brushes gets as short as 8 mm, replace it with a new one, for, if you don't, chances are that you'll have a rectification problem which may cause machine failure. (Fig.31)

- (1) Loosen the tap screws to remove the cap.
- (2) Take out the Carbon Brush and replace it with a new one.
- (3) Put the cover on and securely tighten the tap screws. When tightening the tap screws, see that the tap screws are screwed in along the existing screw threads – without cutting new threads.
- (4) After replacement, run the machine with no load for approx. 10 minutes.

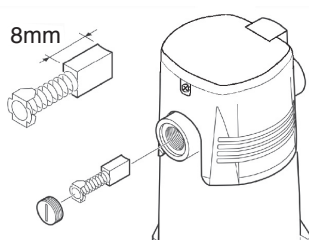

Fig. 31

9 OPTIONAL PARTS

9-1. Nitto-Brand Cutting Oil



CAUTION

Use Nitto-brand Cutting Oil for Atra Ace.

Part No.	Part Name
TB01507	Cutting Oil 2ℓ (Light Blue)

9-2. Pilot Pin (metric size)

Part No.	Part Name	Depth(mm)	Applicable Cutter(mm)
TK01167	Pilot Pin 06025	25	Hi-Broach 12 to 17 dia. Jetbroach 12 to 17 dia.
TJ12696	Pilot Pin 08025		Hi-Broach 17.5 to 35 dia.
TJ15859	Pilot Pin 08035	35	Jetbroach 17.5 to 40 dia.
TK01166	Pilot Pin 06050	50	Hi-Broach 12 to 18 dia. Jetbroach 12 to 17 dia.
TJ16019	Pilot Pin 08050		Hi-Broach 19 to 50 dia.
※(TK00802)	Pilot Pin 0850		Jetbroach 17.5 to 55 dia.
TJ17436	Pilot Pin 08075	75	Jetbroach 17.5 to 55 dia.

※(): Special Order

9-3. Supporting Magnet Ass'y

Part No.	Part Name
TB04374	Supporting Magnet Ass'y

9-4. Sleeve 6.5 Ass'y for Twist Drills (Fig.32)

Part No.	Part Name
TB02536	Sleeve 6.5 Ass'y

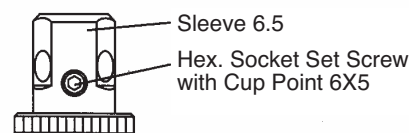

Fig. 32

9-5. Chip Breaker

Chip Breaker Ass'y

Part No.	Part Name
TB07474	Chip Breaker Ass'y
(TQ10787)	Blade
(TQ10695)	Blade Base
(TP14178)	Hex. Socket Head Cap Screw 6×10
(TP01945)	Hex. Socket Head Cap Screw 5×12
(TP01939)	Hex. Socket Screw Key 4
(TP04004)	Hex. Socket Screw Key 5

The part number with () are include in the Ass'y parts written above them.

Mounting Chip Breaker

CAUTION

When setting Chip Breaker, see that the tip of blade may not come into contact with cutting tool. Chip Breaker breaks cutting chips formed in drilling into small pieces and facilitates chip discharging.

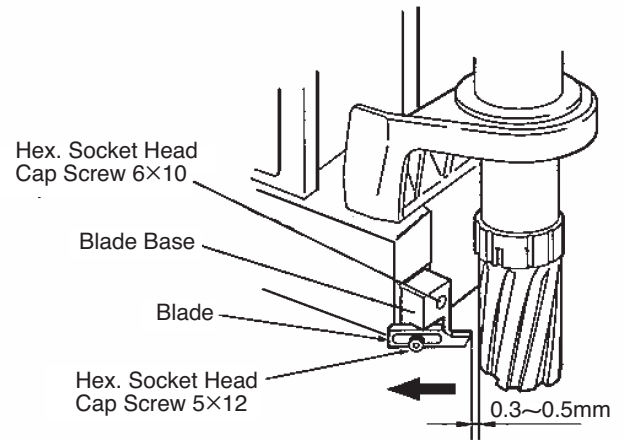

Fig. 33

(1) Mount Blade Base. (Fig.33)

- Use Hex. Socket head Cap Screws 6×10 to mount the Blade Base on the front face of Magnet. See that the bottom face of the Blade Base does not stick out from the bottom face of Magnet. When the bottom face of the Blade Base sticks out from the bottom face of the Magnet, it will lift the Magnet and diminish magnetic attraction.

- Use the Hex. Socket head Cap Screws 5 × 12 to mount a blade to the Blade Base in the direction as shown in the figure.

(2) Mount cutter.

Loosen the Hex. Socket head Cap Screws 5 × 12 and pull the Blade in the direction as shown by the arrow until it no longer moves. And then, mount a cutter.

(3) Set the blade.

Set the Blade in the way that the cutter and the blade will have a clearance of 0.3 mm - 0.5mm and fasten it securely to the Blade Base with Hex. Socket head Cap Screws 5 × 12.

9-6. Cutter

Jetbroach One-touch Type 25L (metric sizes)

Part No.	Diameter x Depth(mm)	Part No.	Diameter x Depth(mm)	Part No.	Diameter x Depth(mm)
TK01148	12 x25	TK01150	14 x25	TK01152	16 x25
TK01149	13 x25	TK01151	15 x25	TK01153	17 x25

Jetbroach One-Touch Type 35L(metric sizes)

Part No.	Diameter x Depth(mm)	Part No.	Diameter x Depth(mm)	Part No.	Diameter x Depth(mm)	Part No.	Diameter x Depth(mm)
TK00301	17.5×35	TK00310	22 x35	TK00319	27 x35	TK00328	35 x35
TK00302	18 x35	TK00311	22.5×35	TK00320	28 x35	TK00602	36 x35
TK00303	18.5×35	TK00312	23 x35	TK00321	29 x35	TK00603	37 x35
TK00304	19 x35	TK00313	23.5×35	TK00322	30 x35	TK00604	38 x35
TK00305	19.5×35	TK00314	24 x35	TK00323	31 x35	TK00605	39 x35
TK00306	20 x35	TK00315	24.5×35	TK00324	32 x35	TK00606	40 x35
TK00307	20.5×35	TK00316	25 x35	TK00325	33 x35		
TK00308	21 x35	TK00317	26 x35	TK00326	34 x35		
TK00309	21.5×35	TK00318	26.5×35	TK00327	34.5×35		

Jetbroach One-Touch Type 50L(metric sizes)

Part No.	Diameter x Depth(mm)	Part No.	Diameter x Depth(mm)	Part No.	Diameter x Depth(mm)	Part No.	Diameter x Depth(mm)
TK01154	12 x50	TK00387	21.5x50	TK00400	30 x50	TK00413	43 x50
TK01155	13 x50	TK00388	22 x50	TK00401	31 x50	TK00414	44 x50
TK01156	14 x50	TK00389	22.5x50	TK00402	32 x50	TK00415	45 x50
TK01157	15 x50	TK00390	23 x50	TK00403	33 x50	TK00416	46 x50
TK01158	16 x50	TK00391	23.5x50	TK00404	34 x50	TK00417	47 x50
TK01159	17 x50	TK00392	24 x50	TK00405	35 x50	TK00418	48 x50
TK00380	17.5x50	TK00393	24.5x50	TK00406	36 x50	TK00419	49 x50
TK00381	18 x50	TK00394	25 x50	TK00407	37 x50	TK00420	50 x50
TK00382	19 x50	TK00395	26 x50	TK00408	38 x50	TK00442	51 x50
TK00383	19.5x50	TK00396	26.5x50	TK00409	39 x50	TK00443	52 x50
TK00384	20 x50	TK00397	27 x50	TK00410	40 x50	TK00444	53 x50
TK00385	20.5x50	TK00398	28 x50	TK00411	41 x50	TK00445	54 x50
TK00386	21 x50	TK00399	29 x50	TK00412	42 x50	TK00446	55 x50

Jetbroach One-Touch Type 75L(metric sizes)

Part No.	Diameter x Depth(mm)	Part No.	Diameter x Depth(mm)	Part No.	Diameter x Depth(mm)	Part No.	Diameter x Depth(mm)
TK01036	17.5x75	TK01012	27 x75	TK01022	37 x75	TK01032	47 x75
TK01003	18 x75	TK01013	28 x75	TK01023	38 x75	TK01033	48 x75
TK01004	19 x75	TK01014	29 x75	TK01024	39 x75	TK01034	49 x75
TK01005	20 x75	TK01015	30 x75	TK01025	40 x75	TK01035	50 x75
TK01006	21 x75	TK01016	31 x75	TK01026	41 x75	TK01112	51 x75
TK01007	22 x75	TK01017	32 x75	TK01027	42 x75	TK01113	52 x75
TK01008	23 x75	TK01018	33 x75	TK01028	43 x75	TK01114	53 x75
TK01009	24 x75	TK01019	34 x75	TK01029	44 x75	TK01115	54 x75
TK01010	25 x75	TK01020	35 x75	TK01030	45 x75	TK01116	55 x75
TK01011	26 x75	TK01021	36 x75	TK01031	46 x75		

Hi-Broach One-Touch Type 25L(metric sizes)

Part No.	Diameter x Depth(mm)	Part No.	Diameter x Depth(mm)	Part No.	Diameter x Depth(mm)	Part No.	Diameter x Depth(mm)
TK00698	12 x25	TK00341	21.5x25	TK00354	30 x25	TK00710	42 x25
TK00699	13 x25	TK00342	22 x25	TK00355	31 x25	TK00711	43 x25
TK00700	14 x25	TK00343	22.5x25	TK00356	32 x25	TK00712	44 x25
TK00701	15 x25	TK00344	23 x25	TK00357	33 x25	TK00713	45 x25
TK00702	16 x25	TK00345	23.5x25	TK00359	34 x25	TK00714	46 x25
TK00703	17 x25	TK00346	24 x25	TK00361	35 x25	TK00715	47 x25
TK00335	17.5x25	TK00347	24.5x25	TK00704	36 x25	TK00716	48 x25
TK00336	18 x25	TK00348	25 x25	TK00705	37 x25	TK00717	49 x25
TK00337	19 x25	TK00349	26 x25	TK00706	38 x25	TK00718	50 x25
TK00338	19.5x25	TK00351	27 x25	TK00707	39 x25		
TK00339	20 x25	TK00352	28 x25	TK00708	40 x25		
TK00340	21 x25	TK00353	29 x25	TK00709	41 x25		

Hi-Broach One-Touch Type 50L(metric sizes)

Part No.	Diameter x Depth(mm)	Part No.	Diameter x Depth(mm)	Part No.	Diameter x Depth(mm)	Part No.	Diameter x Depth(mm)
TK00721	12 x50	TK00731	22 x50	TK00741	32 x50	TK00751	42 x50
TK00722	13 x50	TK00732	23 x50	TK00742	33 x50	TK00752	43 x50
TK00723	14 x50	TK00733	24 x50	TK00743	34 x50	TK00753	44 x50
TK00724	15 x50	TK00734	25 x50	TK00744	35 x50	TK00754	45 x50
TK00725	16 x50	TK00735	26 x50	TK00745	36 x50	TK00755	46 x50
TK00726	17 x50	TK00736	27 x50	TK00746	37 x50	TK00756	47 x50
TK00727	18 x50	TK00737	28 x50	TK00747	38 x50	TK00757	48 x50
TK00728	19 x50	TK00738	29 x50	TK00748	39 x50	TK00758	49 x50
TK00729	20 x50	TK00739	30 x50	TK00749	40 x50	TK00759	50 x50
TK00730	21 x50	TK00740	31 x50	TK00750	41 x50		

10 Ordering Parts

When ordering parts from sales agent, please be sure to give them part number, part name and quantity.

11 Exploded Diagram

WARNING

This diagram is for reference only. Do not attempt to service or repair the Nitto Portable Magnetic Drilling Machine. Do not take the machine apart. Contact an authorized Nitto dealer for all service and repair of the machine. Improper service and repair can cause accidents and severe injuries. Never attempt to modify the machine. Never attempt to service or repair the machine yourself.

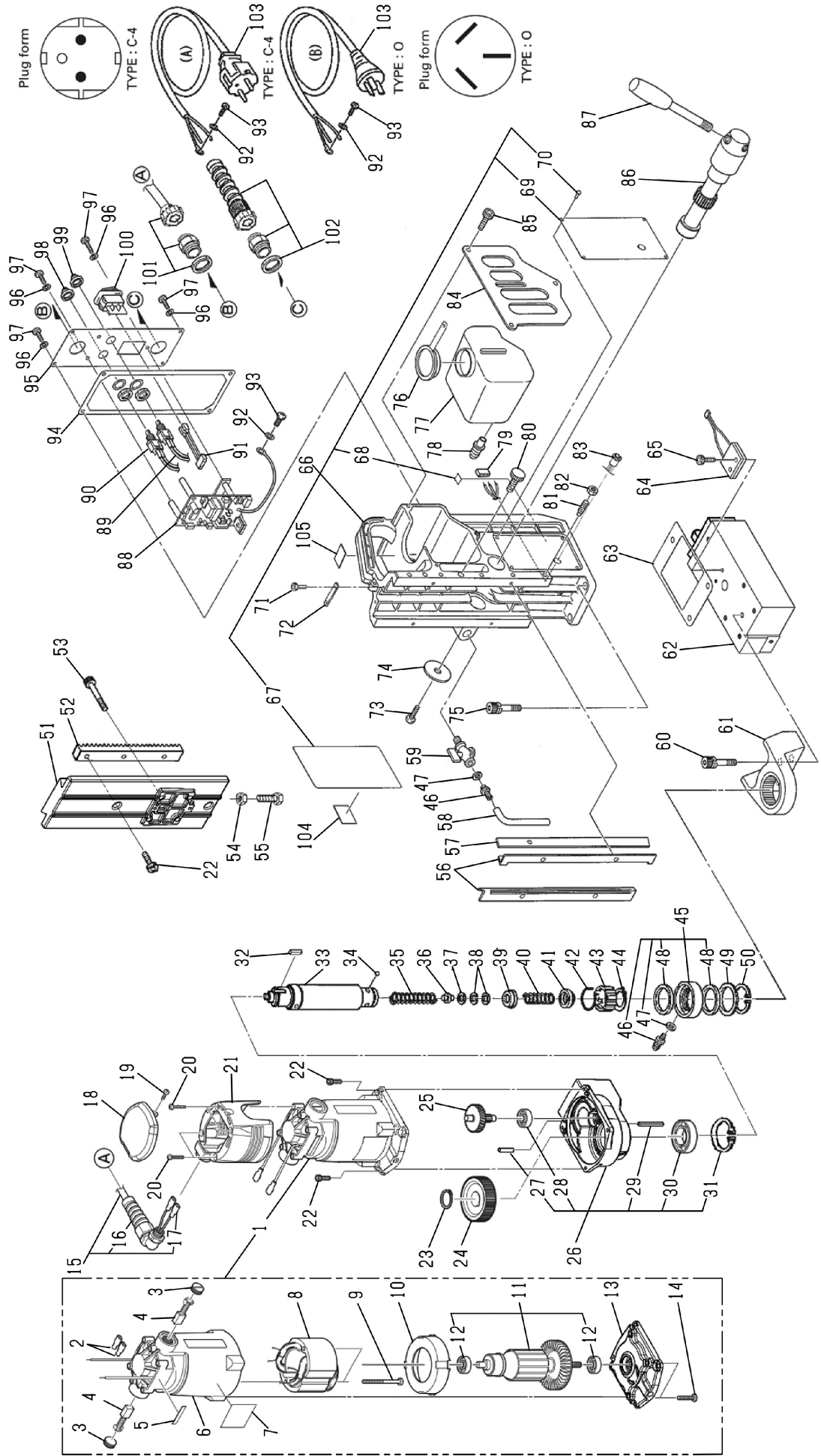

No.	Part No.	Part Name	Q'ty	Price
1	TB10217	Drill Motor Ass'y	1set	
2	(TQ12299)	Male Terminal TMEDN630809-MA	2	
3	(TQ11581)	Brush Cap	2	
4	(TB07700)	Carbon Brush Ass'y	1set	
5	(TQ11585)	Label Voltage 230V	1	
6	(TB07723)	Motor Case Ass'y	1set	
7	(TQ11565)	Label Arbor Warning	1	
8	(TQ11583)	Stator 230V	1	
9	(TQ11584)	Pan Head Tapping Screw 5 x 60	2	
10	(TQ11582)	Fan Case	1	
11	(TB07724)	Armature Ass'y 230V	1set	
12	(TQ11925)	Ball Bearing 608LLB	2	
13	(TB10263)	Motor Flange Ass'y	1set	
14	(TQ11337)	Pan Head Tapping Screw 5 x 25	4	
15	TB10265	Connecting Cable Ass'y A	1set	
16	(TQ06824)	Cord Protector	1	
17	(TQ11503)	Female Terminal TMEDN630820-FA	2	
18	TQ13797	Motor Head Cover B	1	
19	TP14489	Pan Head Tapping Screw 4 x 10	1	
20	TQ13101	Pan Head Tapping Screw 4 x 25	4	
21	TQ13796	Motor Head Cover A	1	
22	TP01945	Hex. Socket Head Cap Screw 5 x 12	7	
23	CQ02200	External Retaining Ring C-25	1	
24	TQ15119	Spur Gear 0.8 x 83	1	
25	TB10264	Gear Shaft Ass'y	1set	
26	TB10222	Gear Box Sub Ass'y	1set	
27	(TQ12425)	Knock-pin MS5-15	1	
28	(TP12419)	Ball Bearing 628ZZ	1	
29	(TP03261)	Spring Pin 4 x 26 AW	1	
30	(TQ15116)	Ball Bearing 6005LLU	1	
31	(CP20569)	Internal Retaining Ring C-47	1	
32	TQ15120	Parallel Key 6 x 6 x 20	1	
33	TQ15117	Spindle Arbor	1	
34	TB01672	Ball 5/16 Ass'y	1set	
35	TQ10649	Spring 1.4 x 16.2 x 149	1	
36	TQ01895	Pilot Spacer	1	
37	TP15848	Spacer 10.5 x 19 x 5	1	
38	TP13905	Internal Retaining Ring RTW-19	2	
39	TB01348	Washer Ass'y	1set	
40	TQ01898	Spring 0.8 x 12 x 31	1	
41	TB01349	Push Ring Ass'y	1set	
42	TQ01896	Rotating Spring	1	
43	TQ01897	Sleeve	1	
44	TP15239	External Retaining Ring C-28	1	
45	TB00713	Oil Ring Ass'y	1set	
46	(TP14500)	Hose Nipple	2	
47	(CP21947)	Packing S-4.7 x 8 x 0.8	2	

No.	Part No.	Part Name	Q'ty	Price
48	(TP14499)	Oil Seal GD38 x 48 x 4	2	
49	TP12773	Washer 38.5 x 54 x 1	1	
50	TP14969	External Retaining Ring IS1W-38	1	
51	TQ15113	Slide Board	1	
52	TP12776	Rack	1	
53	TP04532	Hex. Socket Head Cap Screw 5 x 30	4	
54	TP08584	Hex. Nut M8	1	
55	TP04857	Hex. Bolt 8 x 25	1	
56	TP12777	Slide Plate	2	
57	TQ06773	Gib	1	
58	TB01098	Tube 4.7 x 3000 Ass'y (150mm)	1set	
59	TP14495	P valve PT1/8	1	
60	TQ03346	Hex. Socket Head Cap Screw 8 x 30 With Spring Washer	3	
61	TB05407	Bracket Ass'y	1set	
62	TB07566	Square Pole A Ass'y	1set	
63	TQ07088	Packing Pole	1	
64	TB01363	Side Slip Detection Function Ass'y	1set	
65	TQ10600	Hex. Socket Head Cap Screw 4 x 18	2	
66	TB10210	Body Sub Ass'y	1set	
67	(TQ12839)	Label Warning	1	
68	(TQ11282)	Label Earth	1	
69	(TQ15111)	Plate Spec.	1	
70	(TP05136)	Drive Rivet N0.2 x 4.8	4	
71	TP04715	Hex. Socket Head Cap Screw 4 x 8	2	
72	TQ11074	Rack Stopper	1	
73	TQ04806	Hex. Socket Button Head Screw 8 x 15	1	
74	TQ07081	Washer 30 x 8.5 x 3.2	1	
75	TQ03344	Hex. Socket Head Cap Screw 8 x 20 With Spring Washer	3	
76	TQ11062	Rubber Cap	1	
77	TQ07064	Oil Tank	1	
78	TQ06786	Rubber Plug	1	
79	LQ04533	Housing	1	
80	TP02931	Set Screw	1	
81	TQ00730	Hex. Socket Set Screw with Dog Point 6 x 20	5	
82	TP07419	Hex. Nut Type3 M6	5	
83	TB05739	LED Ass'y	1set	
84	TQ07089	Oil Tank Cover	1	
85	TP06342	Hex. Soker Head Cap Screw 4 x 10	3	
86	TQ07082	Pinion Shaft	1	
87	TQ01681	Rod Handle	3	
88	TB10266	Spare Control Board Ass'y	1set	
89	TB05884	Switch SW2 Ass'y	1set	
90	TB05885	Switch SW3 Ass'y	1set	

No.	Part No.	Part Name	Q'ty	Price
91	TB07445	S Cord Ass'y	1set	
92	TP04464	Toothed Lock Washer B M4	2	
93	LP08489	Binding Head Screw 4 x 6	2	
94	TQ07085	Packing Body	1	
95	TQ11279	Switch Plate	1	
96	TQ00258	Seal Washer M4	7	
97	TP02618	Pan Head Screw 4 x 8	7	
98	TQ10467	Waterproofing Cap Red	1	
99	TQ10085	Waterproofing Cap Black	1	
100	TQ07306	Rocker Switch	1	
101	TQ07097	Cable Connector 3217	1	
102	TQ11075	Cable Connector 3247	1	
103	TB05886	Cabtyre Cord Ass'y (220-240V) TYPE C-4 (A)	1set	
	TB04482	Cabtyre Cord Ass'y (220-240V) TYPE O (B)	1set	
104	LQ04642	Label C-TICK (AUSTRALIA)	1	
105	TQ11877	Label Guarantee (AUSTRALIA)	1	

The part numbers with () are include in the Ass'y parts written above them.

Accessories

No.	Part No.	Part Name	Q'ty	Price
	TP04696	Hex. Socket Screw Key 3	1	
	TP04004	Hex. Socket Screw Key 5	1	
	TP17014	Spanner 8 x 10	1	
	TJ16019	Pilot Pin 08050	1	
	TQ01051	Sub Handle	1	
	TQ12007	Guard	1	
	TQ15123	Instruction Manual	1	
	TA99027	Chain Ass'y	1set	
	TB02145	Cutting Oil 0.5L Ass'y	1set	
	TB10224	Carrying Case Ass'y	1set	



Overseas Affiliates / Offices

NITTO KOHKI U.S.A., INC.

46 Chancellor Drive, Roselle, Illinois 60172, U.S.A.
For Cuplas
Tel : +1-630-924-5959 Fax : +1-630-924-1174
For Machine Tools
Tel : +1-630-924-9393 Fax : +1-630-924-0303
www.nittokohki.com

NITTO KOHKI EUROPE GMBH

Gottlieb-Daimler-Str. 10, 71144 Steinenbronn, Germany
Tel : +49-7157-989555-0 Fax : +49-7157-989555-40
www.nitto-kohki.eu/

NITTO KOHKI EUROPE GMBH UK Branch

Unit A5, Langham Park Industrial Estate, Maple Road,
Castle Donington, Derbyshire DE74 2UT, United Kingdom
Tel : +44-1332-653800 Fax : +44-1332-987273
www.nitto-kohki.eu/

NITTO KOHKI AUSTRALIA PTY LTD

77 Brandl Street, Eight Mile Plains, Queensland 4113, Australia
Tel : +61-7-3340-4600 Fax : +61-73340-4640
www.nitto-australia.com.au

NITTO KOHKI (SHANGHAI) CO., LTD.

Room1506, Suite C, Orient International Plaza,
No.85 Loushanguan Road, Shanghai 200336, China
Tel : +86-21-6415-3935 Fax : +86-21-6472-6957
www.nitto-kohki.cn

NITTO KOHKI (SHANGHAI) CO., LTD. Shenzhen Branch

2005C Shenzhen ICC Tower, Fuhuasanlu 168,
Futian District, Shenzhen, Guangdong 518048, China
Tel : +86-755-8375-2185 Fax : +86-755-8375-2187
www.nitto-kohki.cn

NITTO KOHKI CO., LTD. Singapore Branch

10 Ubi Crescent #01-62, Ubi Techpark Lobby D, Singapore 408564
Tel : +65-6227-5360 Fax : +65-6227-0192
www.nitto-kohki.co.jp/e/nksb/index.html

NITTO KOHKI CO., LTD. Bangkok Representative Office

M&A Business Center, Q-House Convent Bldg.,
38 Convent Rd., Silom, Bangrak, Bangkok 10500, Thailand
Tel : +66-2632-0307 Fax : +66-2632-0308
www.nittobkk.com

NITTO KOHKI CO., LTD. India Liaison Office

3rd Floor, Building No.9-A DLF Cyber City, Phase-III,
Gurgaon, Haryana 122002, India
Tel : +91-124-454-5031 Fax : +65-6227-0192

NITTO KOHKI CO., LTD. Mexico Representative Office

OF1109 Torre Corporativo 1 Piso 11 Central Park Armando Birlain Shaffler
#2001 Col Centro Sur, Queretaro, Qro, C.P. 76090, Mexico
Tel : +52-442-290-1234

INSTRUCTION MANUAL

READ ALL INSTRUCTIONS BEFORE OPERATING THIS TOOL

ATRA ACE Model AO-5575A

PROFESSIONAL TOOL